

SHIMANO

Metanium SA-RB

META-HGR

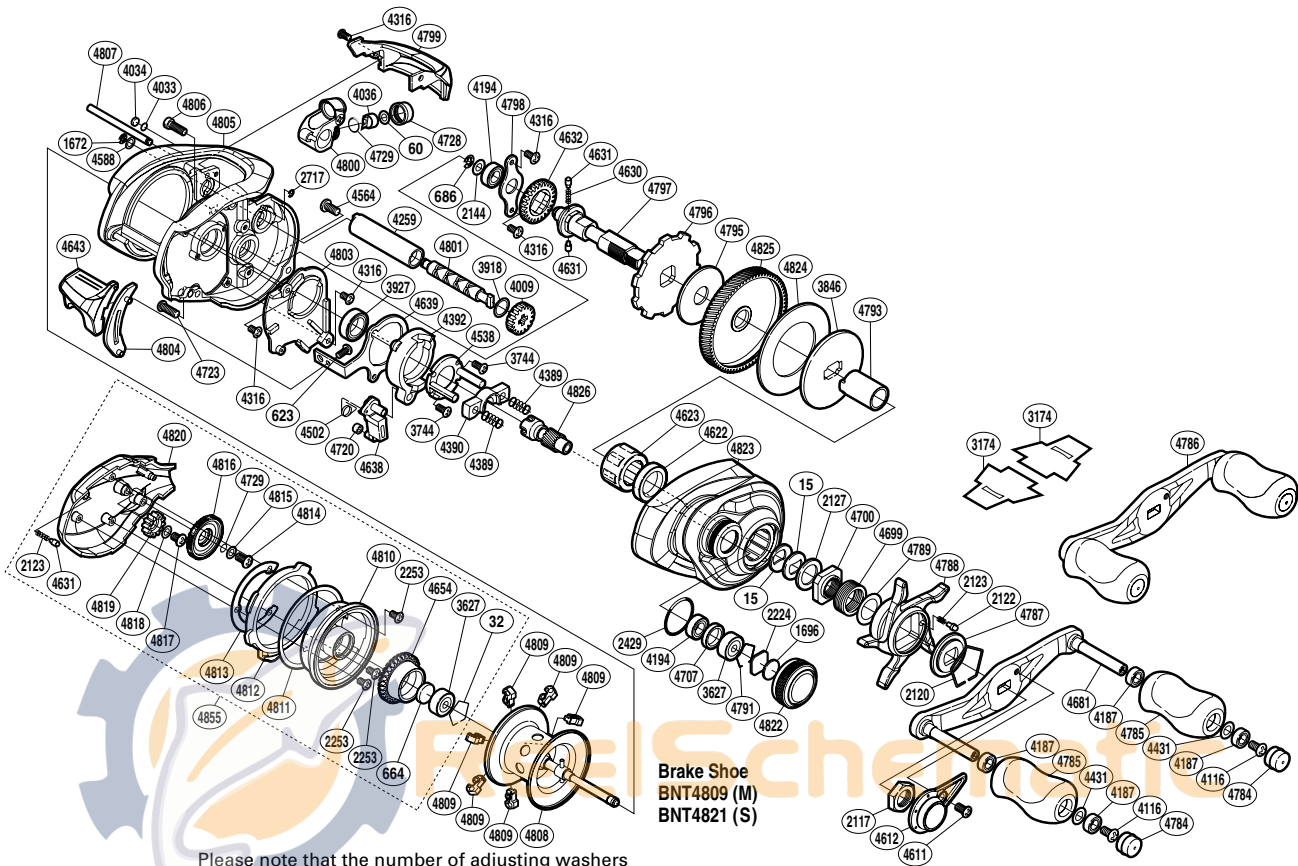

Please note that the number of adjusting washers may not be the same as shown in the exploded views. (Adjustment will vary with each individual product.)

(51RH75200U)

Part No.	Description	Part No.	Description	Part No.	Description
BNT0015	Drag Spring Washer	BNT4392	Clutch Cam	BNT4796	Anti-Reverse Ratchet
BNT0032	Bearing Retainer	BNT4431	Washer	BNT4797	Drive Shaft
BNT0060	Spacer	BNT4502	Clutch Pawl Spring	BNT4798	Drive Shaft Retainer
BNT0623	Screw	BNT4538	Clutch Cam Retainer	BNT4799	Level Wind Protector
BNT0664	Spacer B	BNT4564	Screw	BNT4800	Line Guide
BNT0686	E Lock	BNT4588	Washer	BNT4801	Worm Shaft
BNT1672	E Lock	BNT4611	Screw	BNT4803	Clutch Guard
BNT1696	Cast Control Spacer	BNT4612	Handle Retainer	BNT4804	Clutch Bar Guide
BNT2117	Handle Nut	BNT4622	Drive Shaft Holder Bushing	BNT4805	One-Piece Frame
BNT2120	Click Plate Retainer	BNT4623	Roller Clutch Bearing	BNT4806	Screw
BNT2122	Click Pin	BNT4630	Idle Gear Spring	BNT4807	Level Wind Guide
BNT2123	Click Spring	BNT4631	Idle Gear Pin	BNT4808	Spool Assembly
BNT2127	Star Drag Spacer	BNT4632	Idle Gear	BNT4809	Brake Shoe M
BNT2144	Washer	BNT4638	Clutch Pawl	BNT4810	Brake Case
BNT2224	Spool Tension Spacer	BNT4639	Clutch Plate	BNT4811	Washer
BNT2253	Screw	BNT4643	Quick-Fire II Clutch Bar	BNT4812	Side Plate Cam Lever
BNT2429	O Ring	BNT4654	Brake Pipe Gear	BNT4813	Brake Case Washer
BNT2717	E Lock	BNT4681	Handle Shank Assembly	BNT4814	Screw
BNT3627	Ball Bearing	BNT4699	Star Drag Spring	BNT4815	Washer
BNT3744	Screw	BNT4700	Star Drag Nut	BNT4816	BR Dial
BNT3846	Key Washer	BNT4707	Bearing Spacer	BNT4817	Screw
BNT3918	Washer	BNT4720	Clutch Pawl Bushing	BNT4818	Washer
BNT3927	Ball Bearing	BNT4723	Screw	BNT4819	Idle Gear
BNT4009	Idle Gear	BNT4728	Pawl Cap	BNT4820	Left Side Plate
BNT4033	Washer	BNT4729	O Ring	BNT4822	Cast Control Cap
BNT4034	Anti-Thrust Washer	BNT4784	Handle Knob Seal	BNT4823	Right Side Plate
BNT4036	Line Guide Pawl	BNT4785	Handle Knob	BNT4824	Drag Washer
BNT4116	Screw	BNT4786	Handle Assembly	BNT4825	Drive Gear
BNT4187	Ball Bearing	BNT4787	Star Drag Click Plate	BNT4826	Pinion Gear
BNT4194	Ball Bearing	BNT4788	Star Drag	BNT4855	Left Side Plate Assembly
BNT4259	Level Wind Guard	BNT4789	Washer		
BNT4316	Screw	BNT4791	Bearing Retainer	BNT3174	Reel Seat Spacer (accessory)
BNT4389	Yoke Spring	BNT4793	Roller Clutch Inner Tube	BNT4692	B-100 Oil (accessory)
BNT4390	Yoke	BNT4795	Drag Washer	BNT4821	Brake Shoe S (accessory)